

 **DAHER**

KODIAK
900

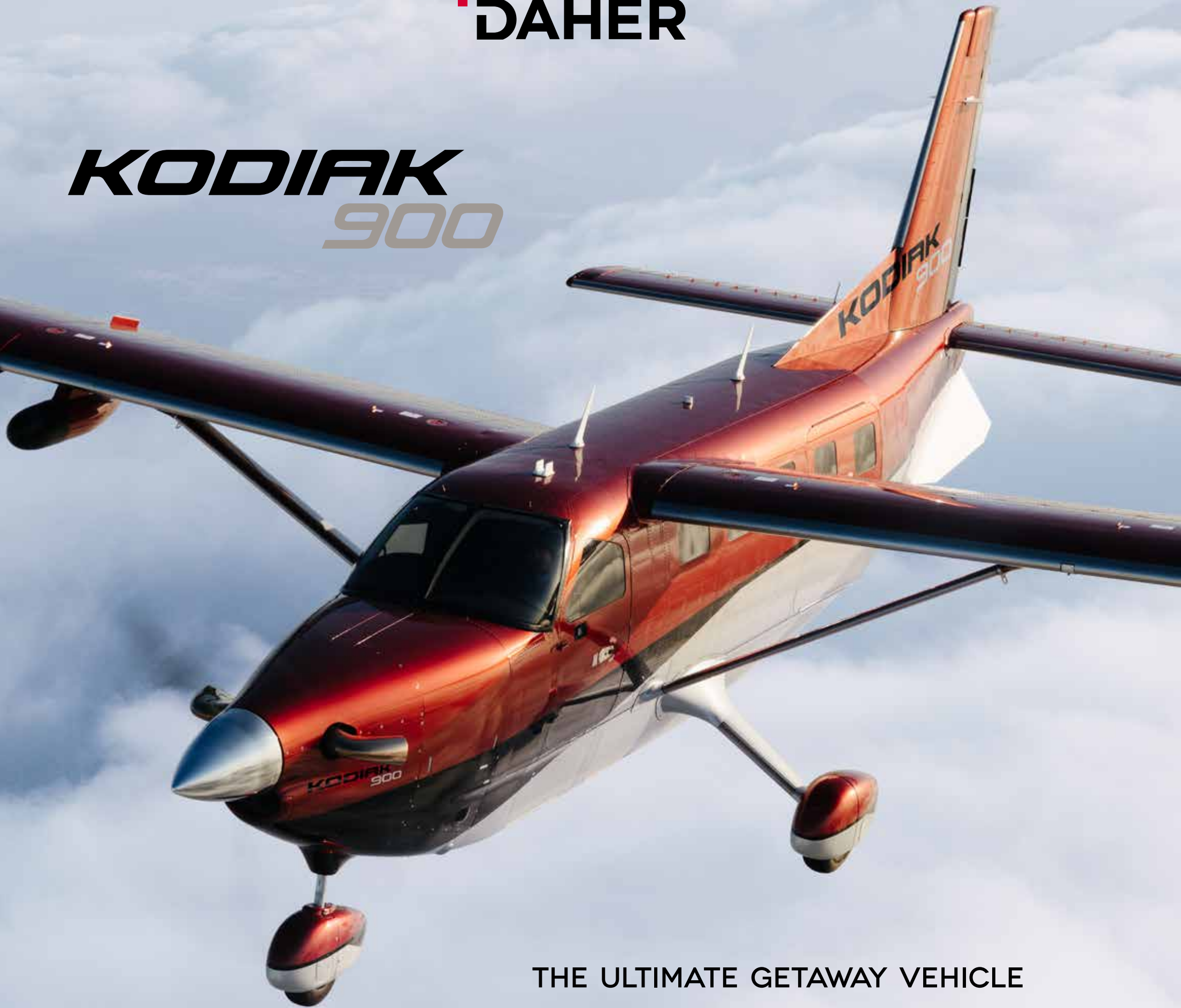

THE ULTIMATE GETAWAY VEHICLE

A NEW AIRCRAFT FOR THE NEW NOMAD

KODIAK *900*

THE KODIAK 900 INHERITS THE BACKCOUNTRY LEGACY OF THE KODIAK 100 AND THE PERFORMANCE-DRIVEN REPUTATION OF THE TBM.

THE KODIAK 900 IS A HYBRID OF BOTH DAHER AIRCRAFT PLATFORMS.

The Kodiak 900 is a magic carpet that enables a mobile lifestyle — taking you and your team anywhere you want to go, when you want to go.

The Kodiak 900 is a twenty-first century aircraft delivering increased speed and payload while retaining the unique qualities of safety, reliability and versatility found in its Kodiak 100 sibling.



WHAT MAKES THE KODIAK 900 UNIQUE?

FAST AT 210 KTAS

SAFEST, MOST MODERN IN ITS CLASS

PERFORMANCE AT ALL STAGES OF FLIGHT

NINE HOURS PLUS LOITER TIME

STALL RESISTANT

SHORT TAKEOFF AND LANDING CAPABLE

LUXURY APPOINTMENTS

FUEL EFFICIENT

INNOVATIVE FROM SPINNER TO TAIL

MULTIPLE CARGO SPACE OPTIONS

LOW OPERATING COSTS

EASILY ADAPTED TO MULTIPLE MISSIONS



THE KODIAK 900 IS DESIGNED FOR THE NEW NOMAD.

Going anywhere while doing everything and still staying connected is the essence of the new mobile lifestyle. The new Kodiak 900 is designed to untether your imagination and deliver a world of experiences.

BUILDING ON THE HERITAGE OF A BACKCOUNTRY ICON

The Kodiak 900 evolved from the legendary Kodiak 100. This backcountry STOL aircraft was designed and then continuously improved for the most demanding work — delivering up to ten people and thousands of pounds of supplies to the world's most remote locations. These were locations that often had very short, very narrow unimproved strips.

The Kodiak 900 has inherited these qualities and improved on them for a new mission — to deliver the freedom to explore the world safely and economically.

THE KODIAK 900 DIFFERENCE: BIGGER, FASTER, MORE ECONOMICAL

The Kodiak 900 inherits all of the remarkable qualities of its Kodiak 100 predecessor and goes many steps further. The Kodiak 900 is a longer aircraft by 3.9 feet — providing more passenger room and more cargo space.

The Kodiak 900 is faster, cruising at 210 KTAS. It has a greater useful load and offers a range of 1,129 nm. The Kodiak 900's maximum takeoff weight is 8,000 lbs, and it is driven by the more powerful Pratt & Whitney PT6A-140A engine. 900 shp delivers a faster climb rate of 1,724 fpm. Like the Kodiak

100, the integrated flightdeck is anchored by the latest Garmin 1000 NXi avionics package in a cockpit designed by pilots for maximum ergonomics and safety.

The Kodiak 900 is safe, efficient and economical. The integrated cargo pod, the streamlined wheel fairings and other engineering improvements contribute to less drag and better fuel efficiency. Improvements to maintenance access also reduce service time and the cost of operation. All this is done without sacrificing the safety, reliability and stall-resistant characteristics it inherited from its Kodiak 100 sibling.

TOUR THE WORLD IN STYLE

The Kodiak 900 is a true touring aircraft. Handcrafted reclining seats together with individual A/C controls and oxygen and headset ports for each seat add up to increased passenger comfort. With a fifth set of passenger windows, the Kodiak 900 ensures breathtaking views on the wide world below.

Like the Kodiak 100, the Kodiak 900 is designed to take everything with you. The main cabin boasts more storage and a large side door for bulky cargo, like motorbikes and other toys. The integrated cargo pod adds another 65 cubic feet of storage that can accommodate long items, like skis or surfboards.



THE KODIAK 900 COMBINES THE ROBUST BACKCOUNTRY HERITAGE OF THE KODIAK 100 WITH THE SPEED, REFINEMENT AND LUXURY OF THE TBM PRODUCT LINE TO CREATE AN AIRPLANE THE MARKET HAS NEVER SEEN BEFORE.



THE NEW NOMAD LIFESTYLE



ONLY TWO WORDS MATTER: SAFETY AND RELIABILITY.

The Kodiak 900 is designed in the 21st century and certified in 2022.

It is the most modern and safest aircraft in its class.

The Kodiak 900 is certified to modern twenty-first century FAA standards, including the latest amendments. There are also over 1000 additional safety enhancements the Kodiak has, which our older competition does not have. Taken together, the Kodiak 900 is the safest and most reliable aircraft you will find in this class.

RIGOROUS TESTING FOR A SAFER AIRCRAFT

The Kodiak 900's seats were dynamically sled tested to 26g's. Older regulations only required seats to be drop tested to 9g's. This old testing method was found unrealistic for measuring survivability and changed in 1988.

Flammability requirements were increased to include the entire airframe (firewall to cargo), not just in passenger areas. All Kodiaks meet and exceed the latest flammability regulations. The Kodiak 900 had to be tested to withstand the harmful effects of a lightning strike. If lightning is nearby, you can rest assured knowing the Kodiak 900 won't lose power to those all-important avionics systems.

Amendment 63 standards require a demonstration of a 50 ft. post-takeoff engine failure, which the Kodiak 900 passed with flying colors. Older regulations did not require this for a type certificate. These items and more make the Kodiak 900 one of the safest airplanes manufactured today.

AN INNOVATIVE WING DESIGN PROVIDES AN EXTRA MARGIN OF SAFETY

The Kodiak 900's unique "discontinuous leading edge" wing design yields performance at all flight envelopes. When most airplanes would stall, Kodiaks continue to fly. When most airplanes would spin, the Kodiak 900 gives the pilot full aileron control, providing an unprecedented level of safety in an airplane of this size.

ENGINE AND POWER TO GET YOU UP AND OUT QUICKLY

The Pratt & Whitney PT6A-140A engine provides the Kodiak 900 with increased power and reliability to deliver an impressive rate of climb and cruise speed.

TOUGH & FORGIVING GEAR FOR ROUGH SITUATIONS

With the new integrated cargo pod and airframe changes, the Kodiak 900's landing gear has shifted aft and moved lower on the airframe. With this placement there are fewer needs for a tail stand for loading and unloading the aircraft. The main gear has been strengthened for increased weight and loads, and it is removable and serviceable with the cargo pod still installed. The nose gear also has an improved configuration for the increased loads of this heavier airplane.

FLY SAFER IN ALL-WEATHER CONDITIONS

A larger coefficient of lift (CL) and modern TKS anti-ice gives the Kodiak an unbelievable margin of safety and performance in even the worst weather conditions. Other weather-related safety features include the enhanced GWX-75 Weather Radar, GTS 800 TAS and WX 500 Stormscope.

GARMIN GFC™ 700 AUTOPILOT: REDUCES WORKLOAD, ENHANCES SITUATIONAL AWARENESS

Fully integrated into the G1000 NXi flightdeck, the GFC 700 is a three-axis, attitude-based autopilot. A fully digital, dual-channel flight control system with unprecedented levels of sophistication and safety in this class of airplane.

BUILT STRONG AND SMART

All Kodiaks, including the Kodiak 100 and the Kodiak 900, are built strong and smart in our factory in Sandpoint, Idaho. The Kodiak 900 is designed to withstand rigorous abuse and keep flying. It is a modern airplane that will still be in use fifty years from now.



THE KODIAK 900 IS THE ALL-PURPOSE MULTI-MISSION PLATFORM

The Kodiak 900 shares a very important characteristic with the original Kodiak 100. That characteristic is versatility. In addition to increased speed, extended range, and a greater payload, the Kodiak 900 is easily converted from transporting passengers to hauling cargo.

The seats can be rearranged in multiple configurations including adaptations for medevac equipment or ISR work stations. The wide fuselage and large, fully-opening side door will accommodate even pallet-sized loads, while the large windows make aerial observations far more effective than the small windows found on conventional aircraft. The integrated cargo pod allows for optimum use of cabin space. For every need, the Kodiak 900 offers a versatile, safe and reliable solution.

COMMERCIAL OPERATIONS

The Kodiak 900 can serve as an airport-to-resort luxury shuttle as well as a touring platform for local sightseeing or excursions to regional tourist attractions. Operators can up their game with the luxuriously appointed features of the Kodiak 900. The Kodiak 900 and the Kodiak 100 are both short takeoff and landing aircraft able to deliver passengers and heavy cargo to the most remote locations. For all-purpose transportation and freight hauling, the Kodiak 900 is the most modern, safe and reliable aircraft in its class.

SPECIAL MISSIONS

The large cabin, extended loiter time, slow speed capability and access to very short, narrow runways make the Kodiak 900 an unmatched choice for law enforcement, maritime control and military ISR operations. It is a flexible platform for many equipment configurations. It is reliable, economical and stealthy. The job of managing remote properties or conducting important environment and wildlife surveys, including LIDAR measurements, is perfectly suited for the Kodiak 900. Remote sensing equipment can be added to the integrated cargo pod. The Kodiak built its reputation responding to humanitarian needs in the most remote corners of the world. The Kodiak 900 continues that vital service for both emergency relief and medevac operations. The ability to get into and out of very small airstrips while carrying heavy cargo make the Kodiak 900 a perfect complement to life preserving operations.

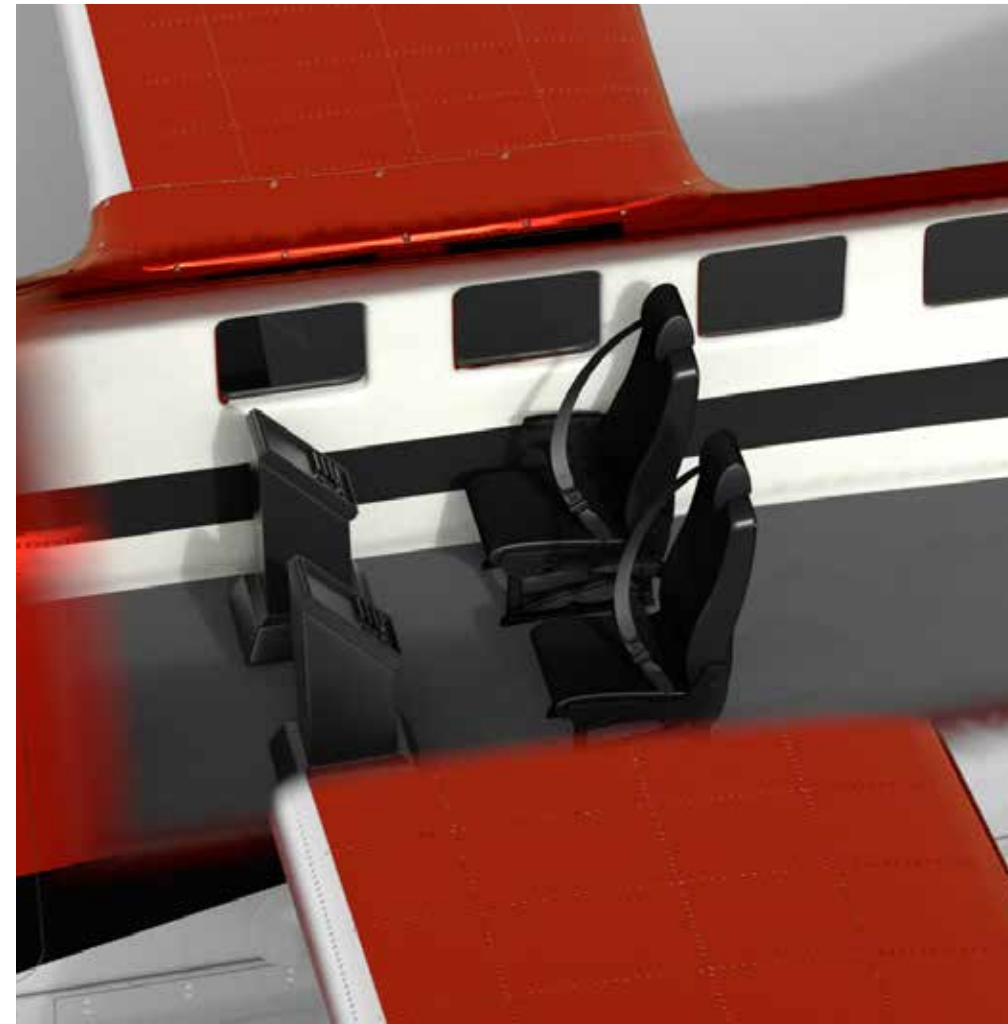

MAX RANGE 1,129 NM	MAX CRUISE SPEED 210 KTAS	NORMAL SEATING 1-10	USEFUL LOAD 3,630 LBS	LOITER TIME 9.2 HRS	TAKEOFF FIELD LENGTH 1,015 FT
-----------------------	------------------------------	------------------------	--------------------------	------------------------	----------------------------------

IT ALL COMES DOWN TO PERFORMANCE

IMPRESSIVE CRUISE SPEED AND CLIMB OUT

The Kodiak 900 can comfortably cruise at 210 KTAS at 12,000 feet. The increased horsepower of the Pratt & Whitney PT6A-140A engine also delivers a fast rate of climb and quick takeoff and landing rolls. The increased performance now yields a 1,720 ft/min climb.

A 1,129 RANGE AND 9.2 HOURS OF FLIGHT TIME

Getting where you want is ensured with the significant 1,129 nm range of the Kodiak 900. When loiter time is important, the Kodiak 900 can stay airborne for over 9.2 hours.

CABIN CONVERTIBILITY AND VERSATILITY

The Kodiak 900 retains the practical utility of the Kodiak 100. Luxurious seats can be rearranged in multiple configurations, including double club seating. For cargo and special operations, the passenger seats can be fully or partially removed.

FLIGHT CHARACTERISTICS

For anyone who has flown the Kodiak 100, the Kodiak 900 flight characteristics are nearly identical and equally impressive despite the increase size and weight. Pilots will have little downtime adapting to the new airframe.

OPERATIONAL ECONOMY

A hallmark of all Kodiaks is impressive fuel efficiency and low maintenance costs. The Kodiak 900 sips 58 gallons a hour while cruising at 210 knots with lower maintenance costs.

IMPROVED AERODYNAMICS

The Kodiak 900 is made faster, in part, due to less drag. Engineering efficiencies have been added throughout the aircraft, including streamlined wheel fairings, flaptrack covers, repositioned VGs, an integrated cargo pod, and numerous refinements to engine intakes and exhaust.

RELIABILITY IS THE KEY TO LONG TERM PERFORMANCE

The Kodiak 900 shares the robust design that is emblematic of the Kodiak 100's backcountry reputation. Extra sturdy gear, a high prop clearance, and higher air intakes mitigate against damage on uneven surfaces. The Kodiak 900 benefits by over a decade of continuous improvements made to the Kodiak 100.



EMPHASIS ON PASSENGER COMFORT

The Kodiak 900's roomy interior is complemented with handcrafted seats, individual passenger amenities and enormous windows on the world below.



LARGER CABIN

The Kodiak 900 is 37 inches longer and 61 cubic feet bigger than its Kodiak 100 sibling. This provides more passenger legroom and more space inside the cabin for luggage and gear.



ALL NEW PASSENGER SEATS

The hallmark of the Kodiak 900 interior is the Summit+ Interior with handcrafted club seats. The new Summit + seats offer unparalleled flexibility with the possibility of a double club configuration, all forward facing seats or multiple combinations. Each seat has left and right armrests and a headrest.



INDIVIDUAL PASSENGER CONTROLS

A true example of rugged refinement, Summit+ features individual oxygen, LED lighting, dual zone touch screen ECS control, phone holder, cup holder, powered headset jack, dual plug headset jack, and USB-A and USB-C charging ports for your portable electronic devices.



AMAZING VIEWS

With an extra set of large windows, the Kodiak 900 provides a breathtaking view of the world below.



MULTIPLE STORAGE OPTIONS

The Kodiak 900 now contains two large storage options. The integrated cargo pod has four access doors including one for long cargo, like skis. The fuselage is larger affording increased in-cabin storage. Bulky items can be loaded through the extra-large side door.



THE BRAINS BEHIND THE BRAWN: ADVANCED TECHNOLOGY FOR ENHANCED CONTROL.

The new Kodiak 900 has all the latest avionics features found in the Kodiak 100, Series III.

- Reduces cockpit workload.
- Enhances situational awareness.
- Take off to touch down navigational assistance.
- Full integration of digital and communication platforms.
- Synthetic vision and weather radar.
- Integrated autopilot.

G1000 NXI NEW FEATURES

Two of the new features that have been brought to the G1000 NXi are 3-D audio and WireAware. Both features increase the pilot's situational awareness and safety. 3-D audio gives the pilot spatial awareness allowing them to identify the location of different radio transmissions and crew and passenger ICS, with advance auditory signaling from the avionics system into the headset.

WireAware graphically overlays comprehensive powerline location and altitude information on the moving map. This Kodiak product line is often used in missions requiring low altitude flight, and is an essential safety tool which will be standard equipment on all Kodiak 900s. Speaker ambient noise compensation is a new feature that automatically adjusts the cockpit volume to appropriate levels for the current environment.

NEW BUS ARCHITECTURE

The electrical system and bus architecture has been completely redesigned and engineered to simplify ease of use and maintenance. With a redesigned bus architecture, the Kodiak 900 was designed with pilot workload and safety in mind. With four busses (Essential, Main, Secondary Flight, and Auxiliary) the process of troubleshooting and flows becomes easier for operators. In the event of an electrical failure the system is designed to auto-shed non-essential systems to simplify pilot tasks in high workload situations. In addition, the circuit breaker panel has been updated to follow the bus architecture, making things easy to find quickly in the event they're unexpectedly needed. In addition, the Kodiak 900 has a 300-amp starter/generator and a 60-amp alternator, which is key for high demand electrical needs like special missions operators. The continuous draw under normal flight conditions is only 55 amps, leaving 245 available for special mission's needs.

VERSATILE COCKPIT

The Kodiak 900 cockpit and instrument panel were designed with ergonomics and safety in mind. Pilots will enjoy flying the Kodiak 900 with the seamlessly integrated G1000 NXi and newly relocated GFC 700 autopilot. Moving the GFC 700 panel above the MFD not only improves ergonomics, it allows commercial and special missions operators ample room to customize the panel with specialized panel mounted equipment.





BUILT BY HAND
IN SANDPOINT
IDAHO

KODIAK
900

MORE POWER. GREATER EFFICIENCY. THE PT6A-140A TURBOPROP.

With the larger Kodiak 900 comes a larger, more powerful and reliable engine.

The Kodiak 900 introduces a new powerplant to the Kodiak family. The Pratt & Whitney PT6A-140A engine is a free-power, two-shaft turbine engine with 900 shaft horsepower or 20% more than on the Kodiak 100. The -140A type consists of two independent turbines: one drives the compressor/gas generator while the second drives the propeller through a reduction gearbox.

FASTER CRUISE SPEED, QUICKER TAKEOFF AND INCREASED RATE OF CLIMB

The PT6A-140A delivers more horsepower, which brings about faster climbs, and higher cruise speeds. The increased performance yields a 1,724 ft/min climb rate, and the Kodiak 900's updated aerodynamic characteristics and performance increase means climb rate is excellent all the way into the flight levels.

A MECHANIC'S DREAM

With the relocation of the battery and reworked/removed MCU system, there is now more room in the engine bay between engine and turbine. The extra space will be welcomed by mechanics. Working on the powerplant will not require removal of other components. The borescope access provides for easy maintenance. The Kodiak 900 also features engineering enhancements to the air intake and ducting systems resulting in significantly less drag and greater efficiency.

A NEW FIVE BLADE HARTZELL PROPELLER

The Kodiak 900 features a new Hartzell constant speed, full-feathering, reversible, hydraulically actuated, composite 5-bladed propeller. This 97-inch diameter propeller diameter adds significant performance to climbs, descents, and cruise, all the while reducing noise both within and outside the aircraft. The prop clearance comes in at 15.4 inches, giving enough room for rough, uneven, off-pavement operations. The propeller edge also features nickel plating to protect the composite material and improving its lifespan.



THE KODIAK 900 SERIES EXECUTIVE PACKAGE

A comprehensive package ensuring performance, efficiency and safety for the Kodiak 900.

THE KODIAK EXECUTIVE PACKAGE HIGHLIGHTS

- AVIONICS PACKAGE ONE
 - GTS 800 TAS/WX-500 STORMSCOPE PACKAGE
 - GDL-69A-XM DATA LINK W/AUDIO INFOTAINMENT
- EXTERNAL CARGO COMPARTMENT (ECC)
- TKS ICE PROTECTION / FIKI CERTIFIED
- SINGLE-POINT REFUELING SYSTEM
- SUMMIT+ INTERIOR PACKAGE
- 4-YEAR KODIAK CARE MAINTENANCE PROGRAM

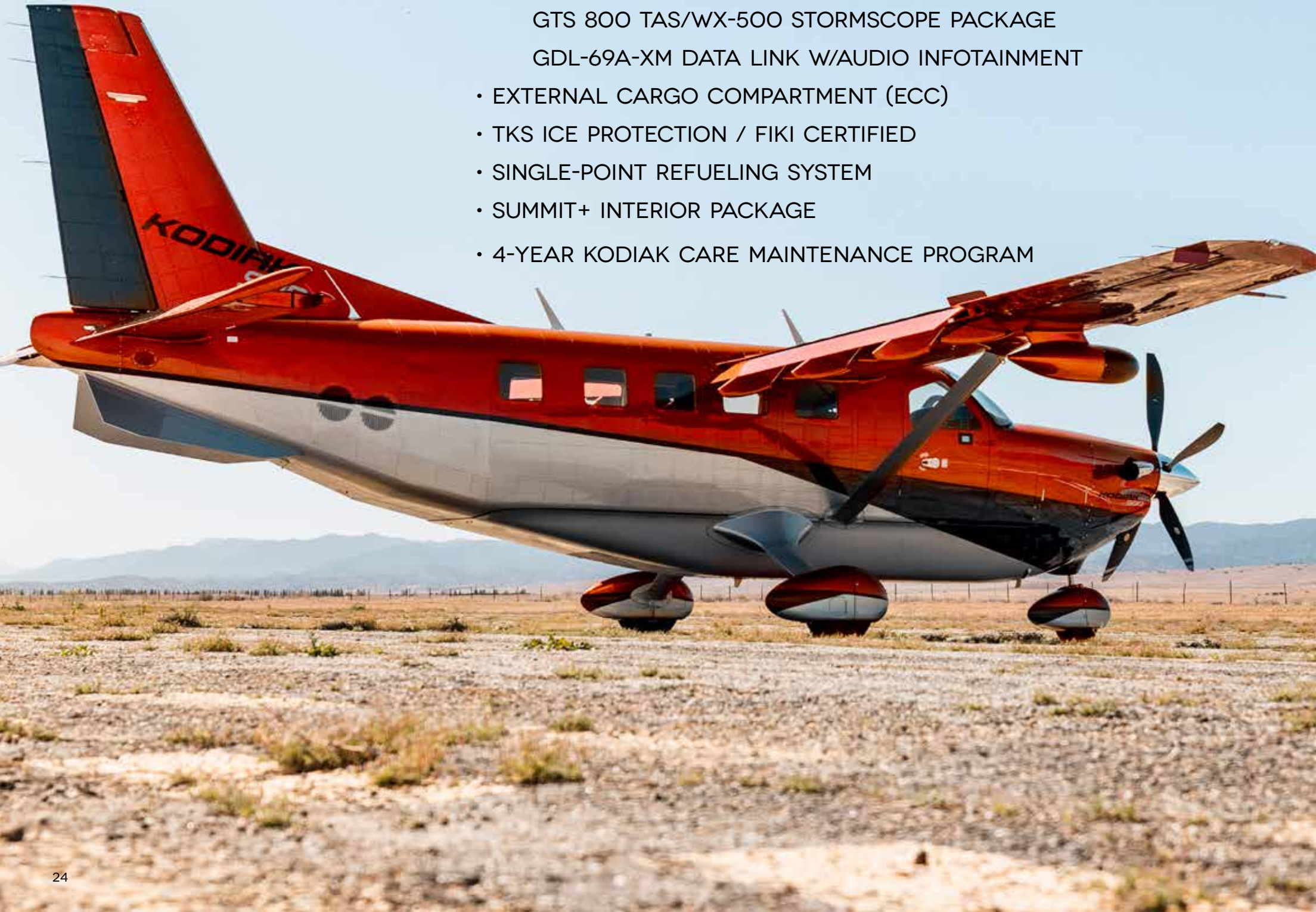

STANDARD EQUIPMENT

Every new Kodiak 900 comes equipped with an extensive set of features and equipment.

This is a partial list of the equipment included in all Kodiak 900 aircraft:

AVIONICS

- Garmin G1000 NXi integrated avionics suite
- GFC 700 autopilot with electronic stability protection, level mode, under-speed protection, coupled go-around and yaw damper
- Dual GPS, AHRS, ADC
- Dual Garmin GMA 1360 audio panels
- GTX 345R Mode-S transponder with ADS-B in/out
- Class-B terrain awareness system
- Garmin Synthetic Vision
- 406 MHz ELT w/ remote switch and GPS enabled
- (2) Cockpit USB ports
- SurfaceWatch Enable Card
- ChartView Enable Card
- Garmin NavData subscription (1 year included)

FLIGHT INSTRUMENTS

- Fully integrated flight instruments in the G1000 NXi
- 4-in-1 electronic standby
- Dual pitot/static systems
- Dual pitot heat
- Angle of Attack (AOA) indexer

ENVIRONMENTAL

- Fully automated touch screen ECS controller
- Cockpit and cabin bleed air heating with silencer
- Forward and aft blowers
- Brushed metal ventilators throughout cockpit & cabin
- State-of-the-art sound proofing
- 10-place oxygen

LIGHTS

- HID landing lights
- Taxi lights with pulse, LED
- Navigation lights (2), LED
- Strobes (2), wingtip mounted, LED
- Beacon (LED)
- Passenger reading lights (8)
- Center aisle ambient LED lights

POWERPLANT

- Engine PWC PT6A-140A, 900 SHP, 4000 HR TBO
- Engine wash ring (integral)
- Oil cooler, high capacity
- Intake inertial separator
- Prop, 5-blade composite, constant speed full feathering, 97 inch
- Pratt & Whitney ESP

ELECTRICAL POWER

- (1) Battery, 24V sealed lead acid
- Starter/generator, 300 amp
- 60 amp alternator

FUEL SYSTEM

- Single-point refueling
- Fuel tanks (2) 322 gallons total
- Float-type fuel level sensors, industry leading accuracy
- Fuel temperature indication

INTERIOR

- Summit+ interior offers 6 club seats
- Air conditioning
- Corrosion proofing
- Non-slip flooring or carpet
- Seats, pilot and co-pilot, articulating, Summit+ trim
- Inflatable crew door seals
- Fire extinguishers (3)
- Eight (8) cabin USB ports
- Cup holders

EXTERIOR

- External Cargo Compartment (ECC)
- Industry leading corrosion proofing
- Wheel pant fairings
- Control surface bonding straps
- (2) crew doors, 180° opening with crew door stay
- Large cargo door

LOOSE EQUIPMENT

- (2) Bose A20 Pilot Headsets
- Custom cover kit
- Crew and passenger oxygen masks; (2) A5 boom cannulas
- (4) Cargo straps and (8) attach fittings

INCLUDED COURSES

- Pilot training (1 Course)
- Maintenance training (1 Course)

KODIAK

CARE

UNMATCHED CUSTOMER CARE

The KodiakCare team are your copilots on the ground. They are dedicated to keeping you flying.

COMPREHENSIVE 4-YEAR AIRFRAME WARRANTY

Each new Kodiak 900 comes with an industry leading warranty. The Kodiak warranty is designed to be seamless, worry-free, and fast with online access to keep you flying.

24/7 ONLINE ACCESS TO THE TECHNICAL PUBLICATIONS PORTAL

The Kodiak technical publications portal is provided with your new aircraft for two years from the date of purchase. The portal provides access to the technical information you need to operate and maintain your Kodiak anytime, anywhere.

24/7 AOG RESPONSE

Our number one commitment is serving the worldwide community of Kodiak owners with world-class service and support. AOG support is available 24 hours a day, 365 days a year by calling or emailing your team of dedicated, knowledgeable Kodiak technicians.

24/7 TECHNICAL SUPPORT

Support is at your fingertips. Your team is always available via email or phone to answer questions and help with troubleshooting.

KODIAK POH/AFM REVISION SERVICE

With the Kodiak Pilot's Operating Handbook and Aircraft Flight Manual revision service, updates are automatically shipped to you whenever a revision to either manual is released during the first two years you own your Kodiak.

ONE-YEAR ENROLLMENT TO CAMP

By providing enrollment in the CAMP Engine Health Monitoring (EHM) and Maintenance Tracking (MTX) service programs at no charge, Kodiak empowers you with the tools to control your operational costs and maintain the aircraft's resale value.

TWO-YEAR OR 400 HOURS* ENROLLMENT IN ESP

To protect the value of your investment and help defer engine depreciation, the ESP (Eagle Service Plan) Gold Lite program is provided at no charge – a value of up to \$50,000 towards covered engine maintenance. (*Up to 400 hours Total Time Since New or two years from date of aircraft delivery, whichever occurs first, for engines enrolling when new.)

Email: kodiakcare@daher.com Technical publications available through the Kodiak Aircraft website at www.kodiak.aero

MAINTAIN OPTIMAL PERFORMANCE

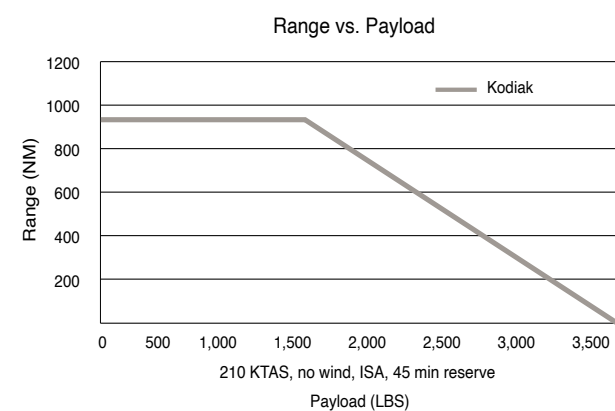
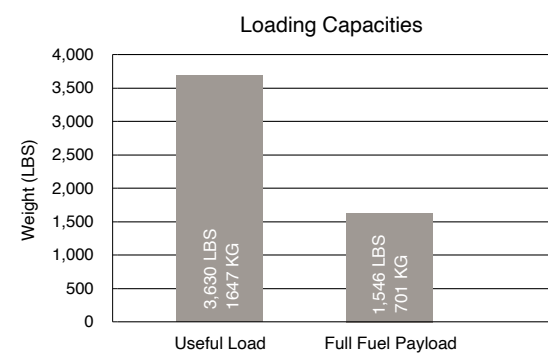
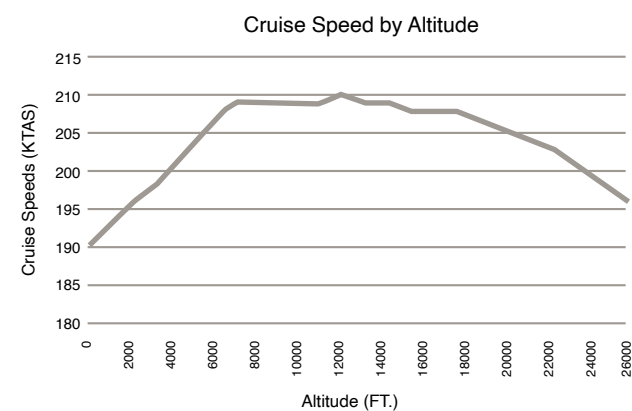

SPECIFICATIONS:

THE KODIAK 900 IS A SMART AIRCRAFT DESIGNED AND BUILT IN THE 21ST CENTURY.

The specifications shown below are for Kodiak 900 aircraft. Specifications for previous aircraft may be different.

WEIGHTS & LOADINGS

Max. Ramp Weight	8,100 lbs	3,674 kg
Max. Takeoff Weight	8,000 lbs	3,629 kg
Base Aircraft Empty Weight	4,470 lbs	2,028 kg
Base Aircraft Useful Load	3,630 lbs	1,647 kg
Fuel Capacity	322 gal	1,219 L
Max. Wing Loading	33.3 lbs/ft ²	162.58 kg/m ²
Max. Power Loading	8.89 lbs/hp	4.03 kg/hp

PERFORMANCE

Stall Speed Vs1 (flaps up)	78 kcas
Stall Speed Vs0 (flaps down)	65 kcas
Rate of Climb (max. cont. at SL)	1,724 fpm 525 mpm
Rate of Climb (10,000 ft)	1,273 fpm 388 mpm
Takeoff Ground Roll	1,015 ft 309 m
Landing Ground Roll	1,460 ft 445 m
Certified Ceiling	25,000 ft 7,620 m

CRUISE PERFORMANCE 210 ktas 389 kph

RANGE & ENDURANCE

INCLUDES 45 MIN. RESERVE, ISA

Max Cruise	210 ktas	389 kph
210 ktas, 12,000 ft (3,658 m)	969 nm	1,794 km
Flight Time	4.3 hrs	

Max Range Cruise	156 ktas, 12,000 ft (3,658 m)	1,129 nm	2,091 km
Flight Time		6.8 hrs	

Max Endurance	102 ktas, 12,000 ft (3,658m)	
Flight Time		9.2 hrs

POWERPLANT Pratt & Whitney PT6A-140A

Takeoff Power	900 hp
Max Continuous Power	900 hp

Propeller (Constant speed, feathering, reversible)

Diameter	97 in 2.46 m
Tip Clearance	15.4 in 39.11 cm

FUSELAGE

Cabin Width	54 in 1.37 m
Cabin Height	57 in 1.45 m
Cabin Length	227 in 5.76 m
Cargo Volume (exc. cockpit)	309 cu ft 8.75 cu m
Overall Length	37.7 ft 11.4 m
Overall Height	16.1 ft 4.9 m
Seats	1-10
Doors	3

Door Sill Height	45 in 1.14 m
Cargo Door (LH side)	
Opening Width	49.25 in 1.25 m
Opening Height	49.25 in 1.25 m

FLIGHT SURFACES

Wing Area	240 ft ² 22.3 m ²
Span	45 ft 13.72 m
Dihedral	3°
Flap Type	Fowler, single-slotted
Horizontal Span	20.3 ft 6.19 m
Overall Height	16.1 ft 4.9 m

LANDING GEAR (Fixed, faired leg, wheel fairings)

Main Gear	8.5 x 10 Cleveland, spring, steel
Nose Gear	6.5 x 8 Cleveland, air-oleo, steel

CERTIFICATION

The Kodiak is certified under Part 23, Amendment 63 of the Federal Aviation Regulations in the Normal Category for day, night, VFR, and IFR flight operations, and certified for flight into known icing when equipped with optional TKS Ice Protection System.

CAPACITY

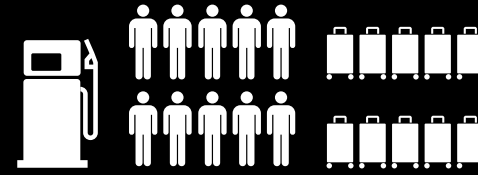

8,000 LBS 3,629 KG
MAX. TAKEOFF WEIGHT



DOUBLE CLUB



8 PASSENGERS, 2 CREW, LUGGAGE



8 PASSENGERS, 2 CREW, BULK LUGGAGE



8 PASSENGERS, CLUB PLUS FORWARD SEATING



2 PASSENGERS, 2 CREW, CARGO OR SPECIAL OPERATIONS



2 CREW, CARGO SPECIAL MISSION

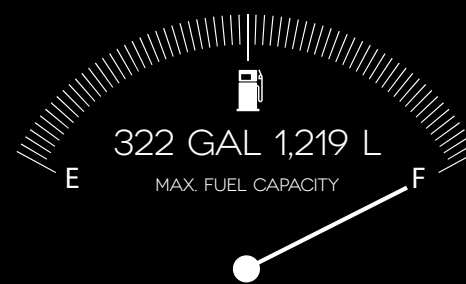

58 GPH 220 L/HOUR

DIMENSIONS

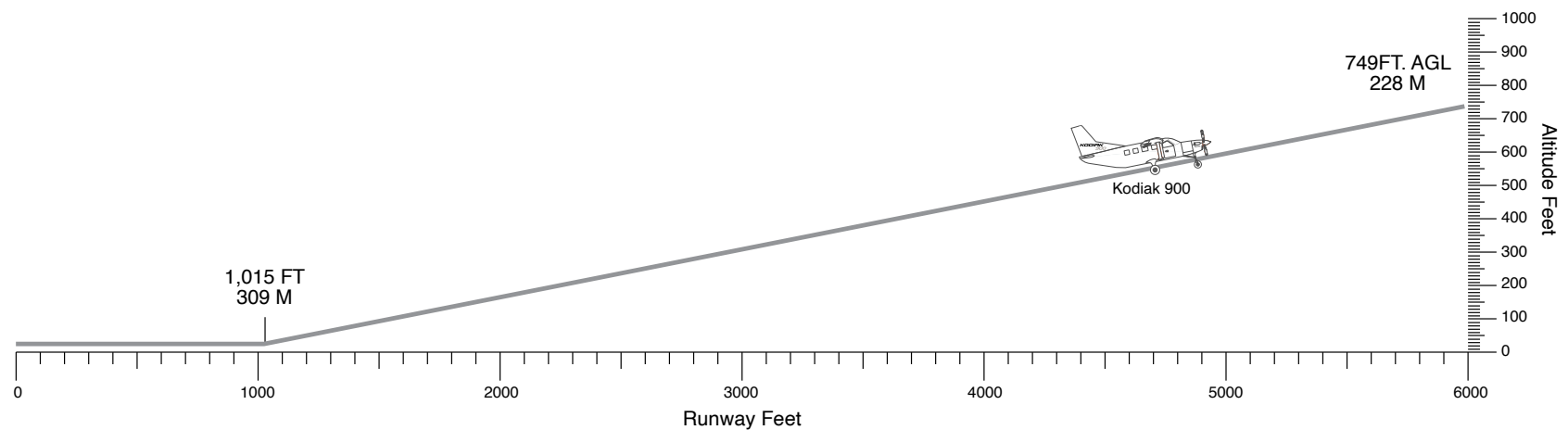
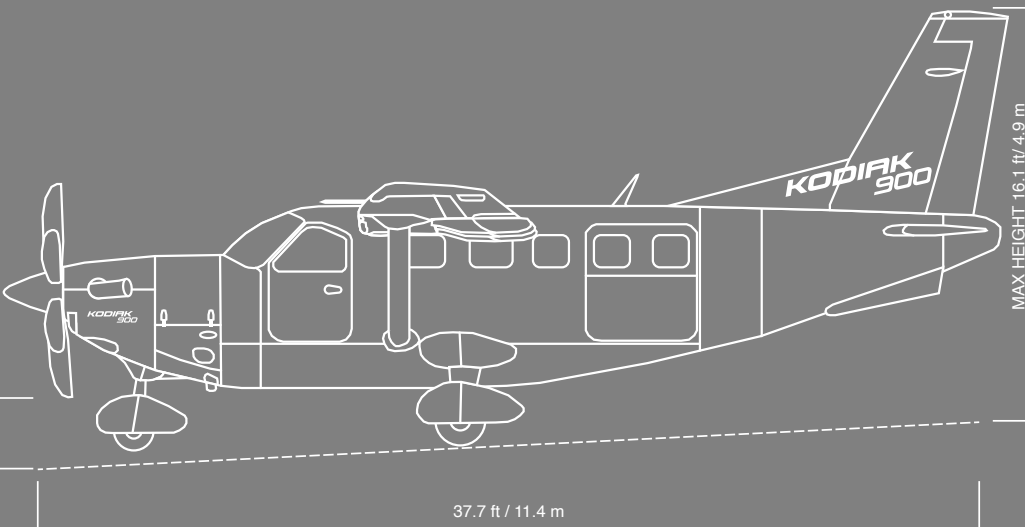
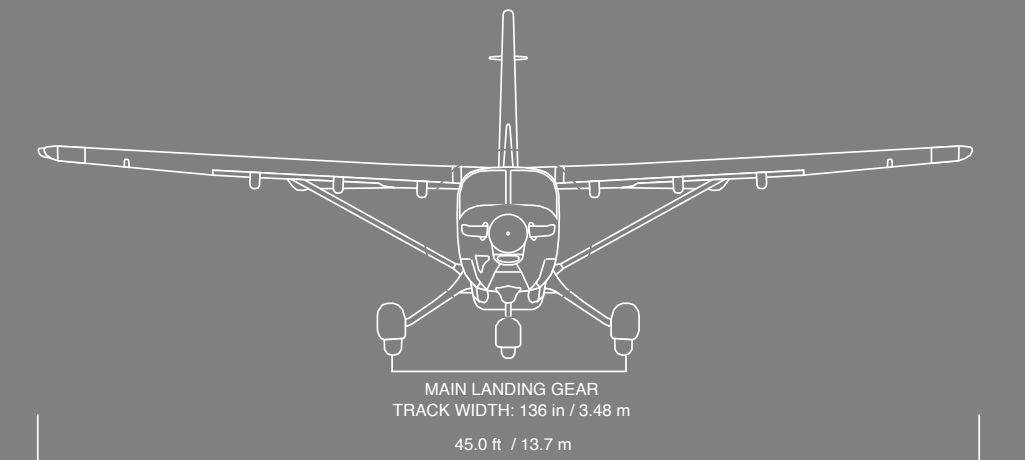
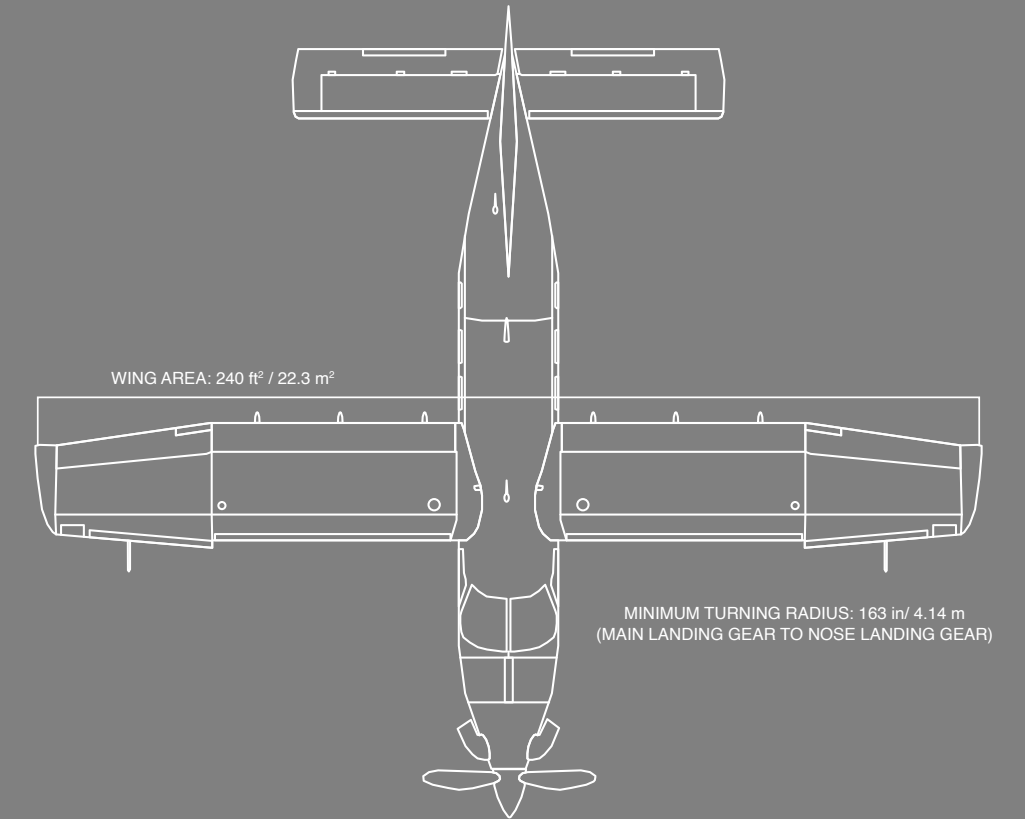



THE DAHER FAMILY

The Kodiak was born in the backcountry and is now the most respected multi-mission STOL aircraft in its class. Today, the Kodiak is part of the international Daher family of aircraft that includes the TBM, made in Tarbes, France and our Kodiak, made in Sandpoint, Idaho.

Both aircraft share the deep aviation roots of Daher that was founded more than one hundred years ago in 1886. Both aircraft leverage the advantages of a worldwide organization with expertise in aviation manufacturing, logistics, technology and service.

THE DESIRE TO DO GOOD, TO BE BETTER

The desire to do good and be better was at the heart of the creation of the Kodiak aircraft. It was the mission of providing the humanitarian community with a long overdue alternative to the world's fleet of aging STOL airplanes that eventually lead to the creation of the Kodiak, certified in 2007 — a modern, heavy-duty plane that could deliver aid and rescue to the most remote reaches of the earth.

Today, Daher Aerospace is prospering. Orders are increasing, the Sandpoint factory floor is expanding, and the introduction of the Kodiak 900 marks 14 years of continuous passion and innovation.

MISSION ACCOMPLISHED? WELL, NOT QUITE.

Another mission, shared by corporate parent Daher, is to provide employment, education and skills to local communities. The scenic, mountain-side communities of Sandpoint, Idaho and Tarbes, France have become the home to dedicated creators of the world's most advanced turboprops.

CRAFTED FOR AVIATORS

We asked our team to tell us what they think about the job they do and the product they build. Here are a few of their responses: "Daher is a company of passionate aviators who believe in changing the status quo of OEM's by making the best hand built, rugged, high payload plane of its class in the world." "We take an uncompromising approach to safety and quality. We make our airplane simple to use, robust, and beautiful." "We are loyal to our roots, and we are loyal to our customers." "We go where others can't." These are the words of maker's pride that you can feel in each Kodiak that comes out of the hangar doors.



KODIAK® is a registered trademark of Daher and licensed to Kodiak Aircraft Company Incorporated.
All data in this document is approximate, for discussion purposes only, and may be subject to certain conditions.
This document does not constitute an offer, commitment, representation or warranty of any kind. All data is subject to change without prior notification. The Kodiak should always be operated according to the approved aircraft operating handbook.

KODIAK *900*

THE ULTIMATE GETAWAY VEHICLE



DAHER AEROSPACE
MANUFACTURER OF THE KODIAK SINGLE-ENGINE TURBOPROP
1200 TURBINE DRIVE SANDPOINT, IDAHO 83864 USA
866.230.7417 KODIAKSALES@DAHER.COM WWW.KODIAK.AERO #FLYKODIAK